

# PRODUCT DATASHEET

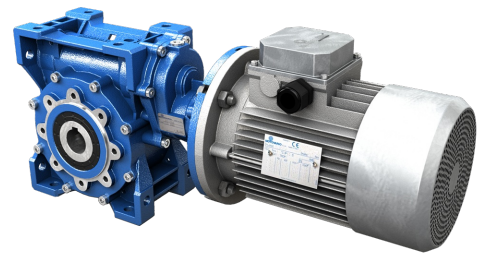

WORMGEARED MOTOR  
WITH PRE-STAGE WITH  
ACCESSORIES/MOTOR

**DATE** 16.08.2019

## CONFIGURATION

CHARACTERISTIC	VALUE
<b>Motor/Inverter Motor</b>	With Motor
<b>Regulations</b>	No
<b>Pre-stage Helical+Worm</b>	HW+NMRV Power
<b>Size</b>	040/090
<b>Ratio (i1xi2)</b>	304,55(6,09x50)
<b>Input Dim.</b>	Ø200x19 (IEC80 B5)
<b>Hollow Output Shaft Dim.</b>	Ø35
<b>Double-Extended Worm Shaft</b>	No
<b>Execution</b>	B5
<b>Mounting Position</b>	B3-B6-B7-B8
<b>Output Flange</b>	No.
<b>Output Shaft</b>	No
<b>Output Cover</b>	No
<b>Torque Arm</b>	No
<b>PC-Lubrication</b>	Eni Telium VSF 320
<b>VI-Output Oil Seal</b>	NBR-Nitrile
<b>VI-Input Oil Seal</b>	ACM-Polyacrylate
<b>VI-Output Bearings</b>	Ball Bearings
<b>VI-Lubrication</b>	Eni Telium VSF 320
<b>Paint</b>	Ral 5010 Blue/Ral 5010 Blue
<b>Supplier</b>	Motovario
<b>Regulations</b>	CE
<b>Motor</b>	Three-Phase
<b>Size</b>	080
<b>Series</b>	High Efficiency
<b>Poles</b>	4
<b>Electrical Execution</b>	Std (Voltage Tolerance +/- 10%)
<b>Service</b>	S1
<b>Voltage</b>	230/400-265/460 V
<b>Frequency</b>	50-60 Hz
<b>Power</b>	0,75 kW
<b>Cooling</b>	Self-Ventilated
<b>Mounting Arrangements</b>	B5
<b>Terminal Box</b>	Pos.1
<b>Flange Dim.</b>	Ø200
<b>Shaft Dim. (DE)</b>	Ø19x40
<b>Rear Shaft End (NDE)</b>	No
<b>Insulation Rating</b>	F
<b>Protection Rating</b>	IP55
<b>Thermal Protectors</b>	No

CHARACTERISTIC	VALUE
<b>Ambient Conditions</b>	Standard
<b>Heaters</b>	No
<b>Condensation Drainage</b>	No
<b>Devices</b>	No
<b>Accessories</b>	None
<b>Terminal Box Cover</b>	Aluminium
<b>Fan</b>	Plastic
<b>Fan Cover</b>	Standard
<b>MO-Notes</b>	No

Values expressed in [mm]

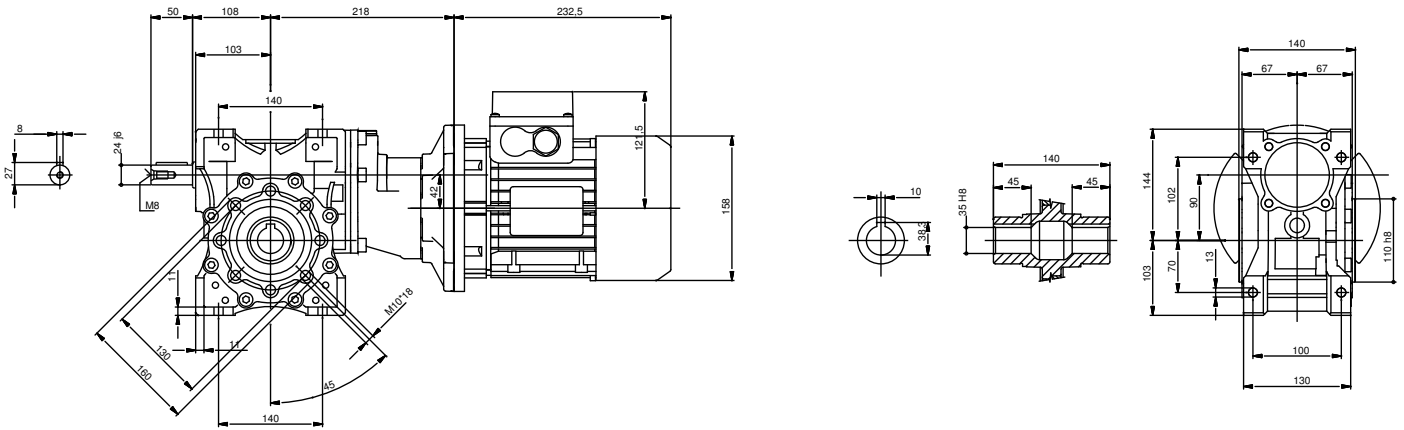

## 0,75 kW (60Hz)

n2 [rpm]	M2 [Nm]	fs	i	Gear reducer	Motor	Fr2 [N]
6,0	708	0,8	304,55	HW040+NMRV...	TH80B4	8180

## MOUNTING POSITIONS

In the case of specific requirements, when ordering, specify the position of the terminal box as shown in the diagram. Unless otherwise specified, the gear reducer is supplied with terminal box in position 1. Terminal box position always refers to HA31 position.

NMRV - NMRV-P - SW

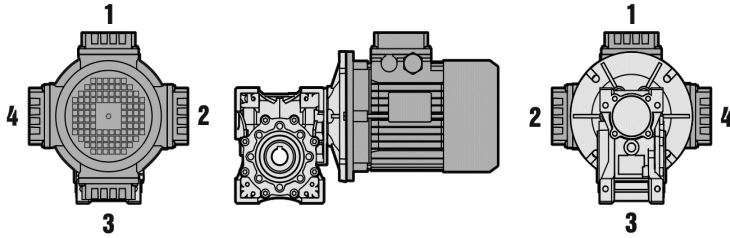

HA31+NMRV/SW

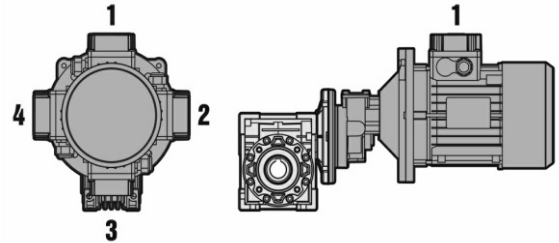

# MOUNTING POSITIONS

The mounting position of the gear unit identifies its space orientation. B3 mounting position, as from a technical point of view, ensures lower oil splash, better lubrication and less heating.

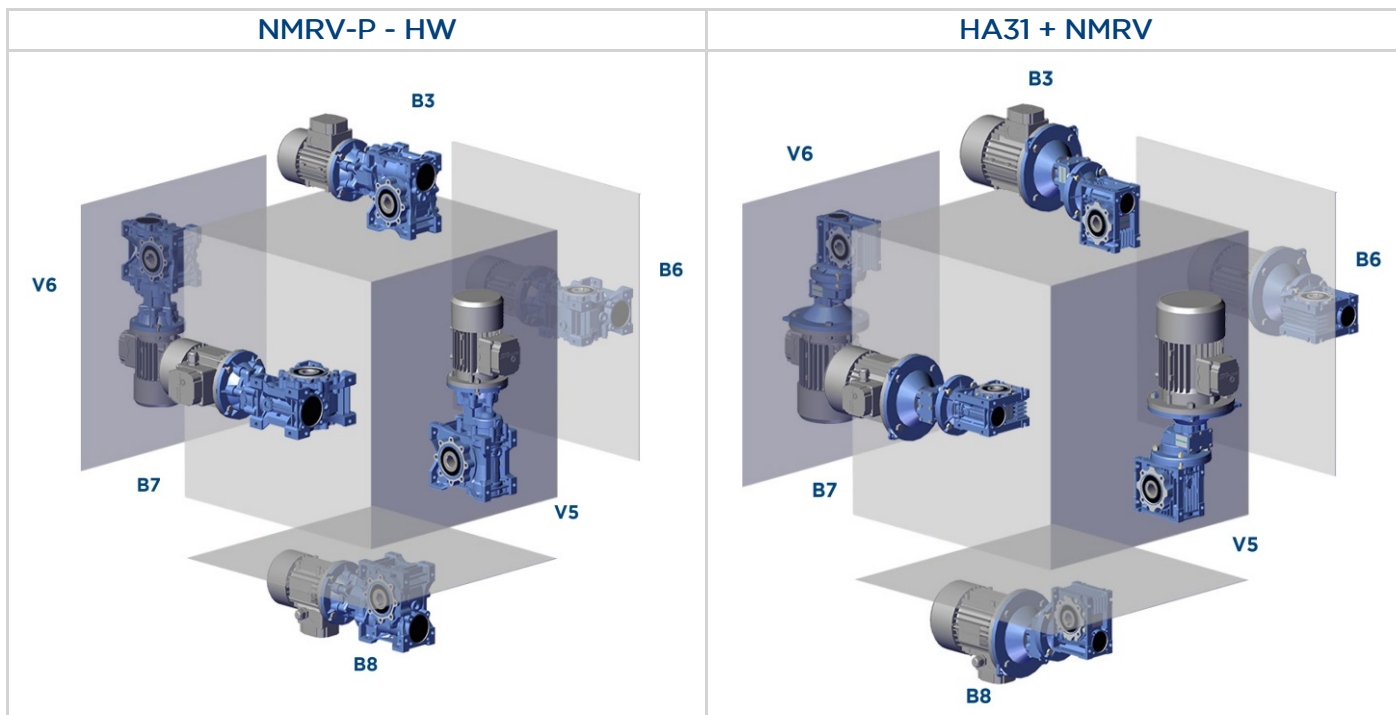

## Execution

### HA31+NMRV

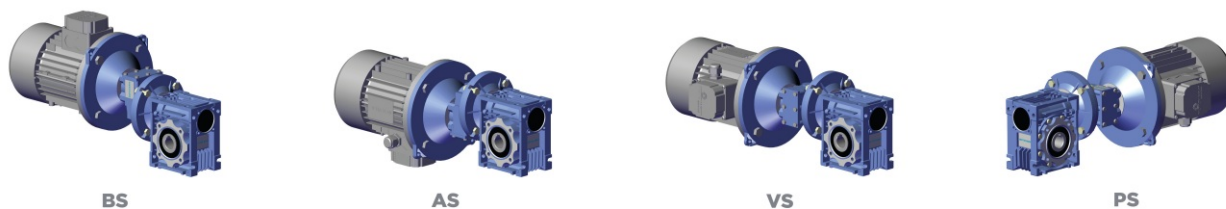

- The gear reducers size 025 - 030 - 040 - 050 - 063 - 075 - 090 - 105 - 110 - 130 - 150 are supplied complete with lubricant for life, synthetic oil, ENI TELIUM VSF. They can be mounted in any position envisaged in the catalogue, except for NMRV 090 - 110 and NRV 075-090-110 for which you must to specify the mounting position.
- For sizes 130 and 150 it is necessary to specify the position, otherwise the gear reducers are supplied with the quantity of oil relating to pos. B3.
- Only reduction units 130 and 150 are fitted with breather, level and oil drainage plugs.
- The pre-stage helical modules are supplied complete with life-long lubricant, synthetic oil, ENI TELIUM VSF. Lubrication is separated from that of the worm gear reducers.

It is recommended, after installation, to replace the closed plug used for transportation with the supplied breather plug.

Quantity of oil in litres -

NMRV	025	030	040	050	130	150
B3	0,02	0,04	0,08	0,15	4,5	7
B8					3,3	5,1
B6-B7					3,5	5,4
V5					4,5	7
V6					3,3	5,1

NMRV-P	063	075	090	110
B3	0,33	0,55	1,15	1,6
B8				
B6-B7				
V5				
V6				

SW	030	040	050	063	075	090	105
B3	0,04	0,08	0,15	0,3	0,55	1	1,6
B8							
B6-B7							
V5							
V6							

HW	HW030		HW040	
	NMRV-P063	NMRV-P075	NMRV-P090	NMRV-P110
B3-B6-B7-B8-V5-V6	0,06	0,09	0,11	0,12

H	A31
B3-B5	0,07

The worm screw rotation is right-handed.

## DIRECTION OF ROTATION - HIGH SPEED SHAFT

NMRV - NRV - SW - ISW



MOUNTING POSITION **B3**

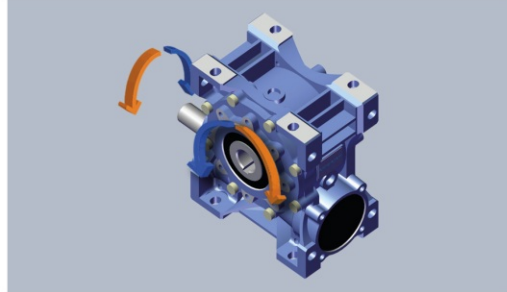

MOUNTING POSITION **B8**

NMRV + NMRV - SW + SW - NRV + NMRV - ISW + SW

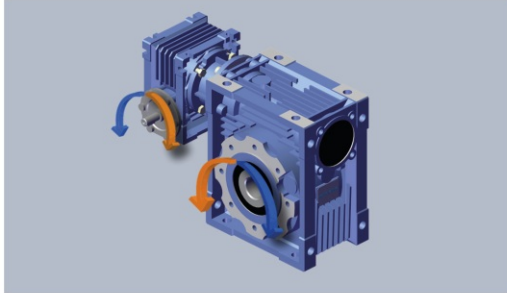

MOUNTING POSITION **AS1**

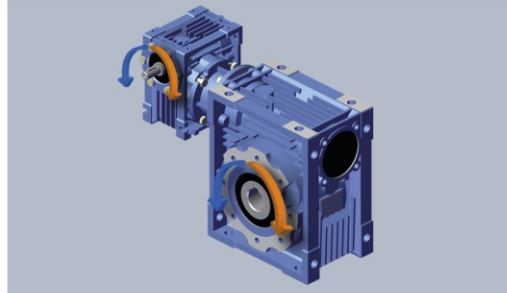

MOUNTING POSITION **BS1**